

Varenummer: 0109055  
 Beskrivelse: Seeger låsering AS 38X2.5  
 Fjederstål  
 Note: Monteres med ZGA tang

## Mål

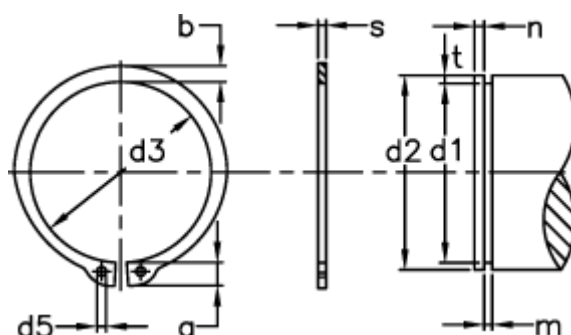

a max	= 6.8	d5 min	= 2.5	s	= 2.50
AN mm <sup>2</sup>	= 127.0	FN kN	= 21.20	t	= 1.00
B	= 2.04	FRg kN	= 18.6	Tang	= ZGA-3
b	= 4.3	FR kN	= 101.0	tol	= -0.07
Betegnelse	= AS 38	g	= 2.0	tol	= +0,25 -0,50
d1	= 36.0	m min	= 2.65	tol	= -0.25
d2	= 38	n abl x 1000	= 15	vægt kg/1000	= 8.00
d3	= 35.2	Nominel træk	= 3.3		